

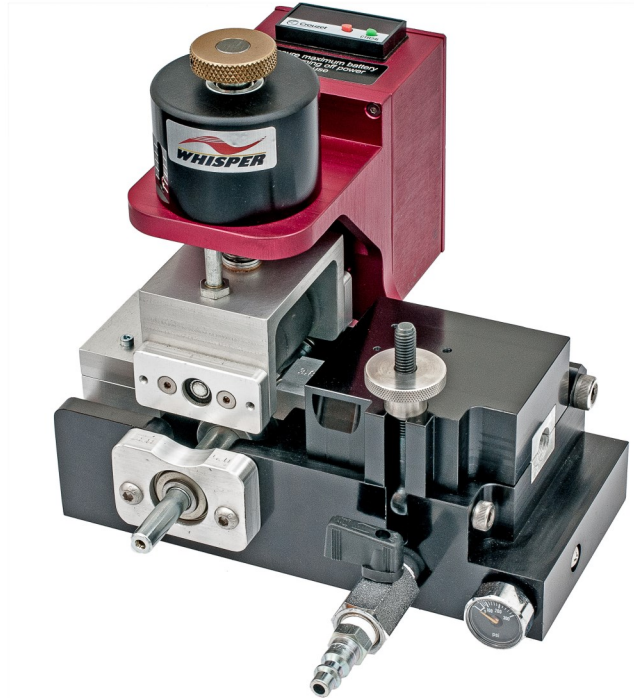

WHISPER MICRO CABLE BLOWING MACHINE for Round Fiber OPERATION & MAINTENANCE



WHISPER – USA CABLE BLOWING MACHINE Copyright © 2019 by General Machine Products (KT), LLC

QC Final Inspection by: _____ Date: _____

Unit Serial Number: _____

Build Date: _____

All rights reserved. No part of this publication may be copied, reproduced or transmitted in any form whatsoever without the written permission of General Machine Products (KT), LLC



GMP • 3111 Old Lincoln Hwy • Trevose, PA 19053 • USA
TEL: +1-215-357-5500 • FAX: +1-215-357-6216 • EMAIL: info@gmptools.com

Dec 2023 USA Ver 4e

Manual Part Number 36003

REVISION HISTORY

Rel.no	Date	Details	Author
01	09/13	Original issue	A KONSCHAK
02	07/14	Updated configuration info Added replacement screws and toolkit info	A KONSCHAK
03	11/15	Updated calibration to include proximity switch	A KONSCHAK
03a	03/16	Added optional accessories	A KONSCHAK
04	11/16	Added photo changes and cable pressure indicator	A KONSCHAK
04a	02/17	Added roller follower kit to spares	A KONSCHAK
04b	07/17	Changed company name	A KONSCHAK
04c	05/18	Updated supplied tools	A KONSCHAK
04d	02/19	Updated fiber range	A KONSCHAK
04e	12/23	Updated photos to reflect correct seal placement	A KONSCHAK

CONTENTS

1. Safety Instructions
2. Critical Points
3. General Description
4. Specification
5. Operating procedures
6. Maintenance
7. Monthly Service – check list
8. Service History Record
9. Tube integrity and Lubrication
10. Recommended Spares List

APPENDICES

- | | |
|-------------------|---|
| Appendix 1 | Cable and tube insert selection chart. |
| Appendix 2 | Determining the correct drill torque setting |
| Appendix 3 | Counter/Ratemeter Programming Instructions |

GMP Limited Warranty can be found at <http://www.gmptools.com/warranty/>

1. SAFETY INSTRUCTIONS

WORK AREA AND GENERAL SAFETY

This Equipment should be used only by personnel who have been given the appropriate training and who are competent to use it. These instructions are to be made available to operators of this equipment at all times. Failure to observe these safety instructions could result in serious personal injury and/or property damage.

1. Read and understand the operation and maintenance manual supplied with this equipment. Keep it in a convenient place for future reference.
2. Keep children and untrained personnel away from this equipment while in operation.
3. Keep all guards and safety devices in place. Do not operate this equipment with guards removed or damaged.
4. Keep hands, feet and loose clothing away from moving parts, especially at cable entry points.
5. Always stop the machine and isolate compressed air and electrical services to carry out lubrication and servicing.
6. Check machine before starting for worn or damaged parts. Check for signs of loose nuts and bolts etc.
7. If machine is left unattended, insure that unauthorized use is prevented.
8. Never leave the machine unattended while in use.
9. Consider the use of safety barriers, especially when used in public places, observe all statutory requirements for working environments.
10. Beware of pinch points involved with rotating components.
11. Beware of hot surfaces, machine uses compressed air.
12. When operating machine always wear appropriate safety clothing, hearing protection, eye protection, hard hat, safety shoes and leather gloves, machine operates with compressed air at up to 220 psi.
13. Prior to installation insure the tube route is connected properly.
14. Beware of exposed electrical contacts. Do not touch, or allow metal objects to come into contact.
15. Machine may cause additional fire hazard if involved in an existing fire due to compressed air.

16. No personnel are to be in manholes or ducts when the Cable Blowing Machine is being operated.
17. The machine must be operated on firm ground.
18. Stay clear of cables or lines under tension.
19. Stay clear of pressurized air line and tube.
20. Only use the machine for its intended purpose. Do not use the roller drive without the air chamber to push or to retrieve cable or blow air in the far end of tube to help cable recovery.
21. Do not place cable drum too close to the Cable Blowing Machine.
22. Do not tamper with pressure relief valves or pressure reducing valves.
23. Ensure the cable drum rotates freely on its stand, the cable should leave from the top of the drum.
24. The cable should enter the machine in a clean and dry condition. In damp, dusty atmospheres, the cable should be cleaned continuously as it enters the machine.

**FAILURE TO DO SO MAY RESULT IN PERSONAL INJURY, AS THE CABLE
COULD BE EJECTED FROM THE CABLE BLOWING MACHINE WITH HIGH
FORCE AND VELOCITY.**

GENERAL PNEUMATIC SAFETY INSTRUCTIONS

The GMP Whisper Micro Cable Blowing Machine is a pneumatic device, using pressurized air to project cable at high velocities. Please observe the following precautions when operating the Cable Blowing Machine:

1. Compressed air can cause flying debris. This could cause personal injury. Always wear personal protective equipment.
2. Ensure no personnel are in the manhole at the far end of the cable run. Severe personal injury may result.
3. Never open the air chamber when pressurized.
4. Only authorized, fully trained personnel should operate the air compressor.

GENERAL ELECTRICAL SAFETY INSTRUCTIONS

The machine has electronic circuits. Observe the following precautions to avoid electrical hazards:

1. Do not operate in water.
2. Do not expose the machine to rain.
3. Refer servicing to qualified service personnel.

2. Critical points that dramatically affect the operation of the cable blowing machine.

- Pressure on the cable should be set as per the instructions.
- Rollers to be closed at all times when cable is installed into machine.
- Cord seals in air chamber correctly fitted to provide good sealing.
- Correct cable seal fitted.
- Tube fully connected and pressure-tested.
- Tube connecting fittings are suitable for operating at 220 PSI air pressure.
- Tube clamp securely tightened.
- Compressor capacity 220 PSI and suitable for size of tube being used.
- Cable drum must be located directly behind and in line with the blowing machine.
- Air chamber, drive rollers, cable guides, must be clean and free from debris, sludge, dirt, water and lubricant.
- The cable must be hand guided into the blowing machine through a dry clean cloth by the operator wearing work gloves.
- Ensure the compressed air supply is not applied to the cable until required amount of cable has been installed.
- The counter/display is powered by (2) 9 volt batteries. To maximize battery life, turn display off by pressing power button on left side of display box when unit is not in use.

DISCLAIMER

General Machine Products (KT), LLC takes care in the design of its products to insure that the cable is protected during installation. Due to the variety and different methods of cable manufacture the responsibility of checking the cable compatibility with the equipment lies with the user. Therefore, GMP can not accept liability for any damage to the cable.

3. GENERAL DESCRIPTION

The GMP Whisper Micro Cable Blowing Machine is designed to install micro fiber cable into micro tubes.

The Whisper uses a user supplied variable speed drill to drive a drive roller. The roller may be changed quickly using one simple tool.

The pressure the roller applies to the cable is adjustable.

A full range of accessories is available to allow the machine to handle a wide range of cables and micro tubes.

The Whisper may be placed on a stand or on the optional tripod kit to bring the cable to a suitable height. The Whisper is supplied with a reinforced soft case which will protect the machine from damage during transit and storage.

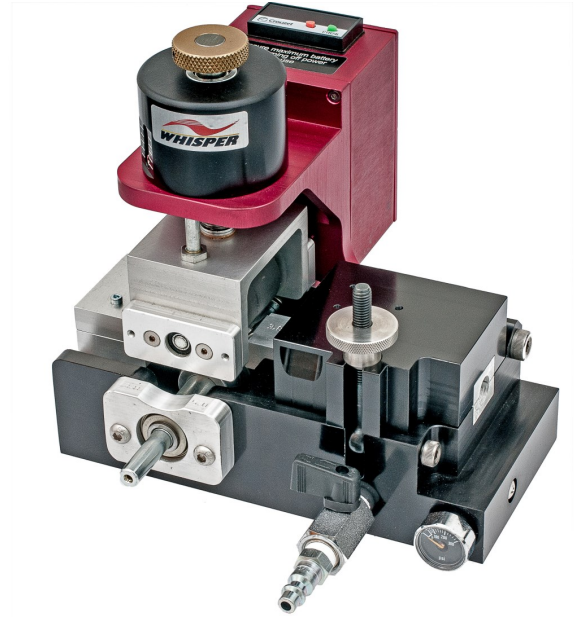

On left is the Whisper assembled for a typical blowing operation. Shown is the unit with the optional Tripod Mounting Kit (P/N 89945) and a user supplied variable speed drill.

4. SPECIFICATIONS

Cable size:	0.12" to 0.33"	3.0 to 8.5 mm
Tube size: (OD)	0.158" to 0.709"	4 to 18 mm
Cable speed:	0-300 ft/min	0-90 m/min
Maximum air pressure:	220 psi.	15 bar.
Power requirements:	Variable Speed Drill with adjustable torque	(not included)
Weight	12 lbs. approx.	5.4Kgs approx.
Dimensions (ht x length x width)	8.5" x 9.7" x 8.1"	216mm x 246mm x 206mm

5. OPERATING PROCEDURE

IT IS IMPERATIVE THAT ALL PERSONS USING, OPERATING OR MAINTAINING THIS CABLE BLOWING MACHINE:

- HAVE RECEIVED COMPREHENSIVE TRAINING IN THE USE OF THIS MACHINE.
- ARE COMPETENT AND AUTHORIZED TO USE IT AND HAVE READ AND UNDERSTAND THIS MANUAL.

GENERAL MACHINE PRODUCTS (KT), LLC CANNOT BE HELD RESPONSIBLE FOR MISUSE OF THIS EQUIPMENT.

Set up for installing cable with the machine mounted above ground:

1. Position the machine in line with the route of the duct.
2. Position the cable drum behind the machine and in line with the machine. See illustration below (this shows a plan view of the recommended set up).

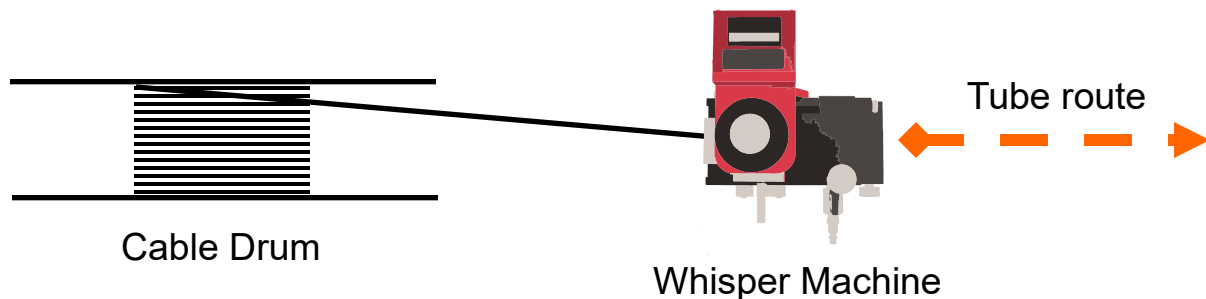

3. Ensure the machine is secure (either on its own stand or a separate suitable stand).
4. Ensure the machine is fitted with the appropriate guides and collets to suit the cable being installed and the tubes into which the cable is to be installed. (See appendix 1 for details of interchangeable parts).

To set the machine up to install cable it will be necessary to:

1. Fit the tube into which the cable is to be installed into the tube clamp and airbox .
2. Fit the cable through the machine. Adjust drive roller tension.
3. Connect the air supply to the machine.
4. Connect the variable speed drill to the machine.

Outfitting the Whisper

When preparing the Whisper for use, you must know the OD of the cable being blown and the size of the duct you are blowing in.

Preparing the Whisper for the proper cable size

Measure the OD of the cable.

Select the corresponding cable collet assembly for the size cable you're blowing



CABLE SEAL COLLET ASSEMBLY

89932	3.0 - 3.8mm
89933	3.8 - 5.0mm
89934	5.0 - 6.4mm
89935	6.4 - 8.5mm

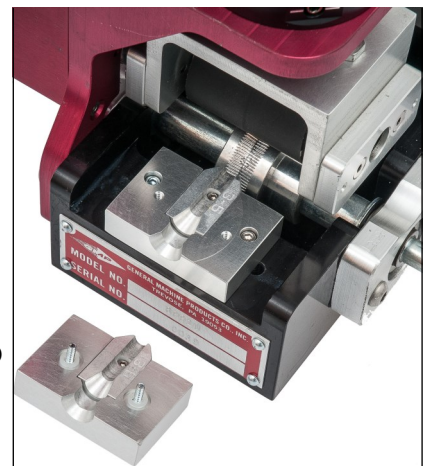

Install Cable Seal Collet Components into the Whisper

A. Install infeed guides

Install infeed guide by removing the two screws retaining the top block of the infeed guide holder. Secure the top and bottom guide halves with their retaining screws. Reattach the top block of the infeed guide holder.

B. Install Cable Guide



Place the guide in the groove on the exit side of the roller



Tighten the mounting screws.

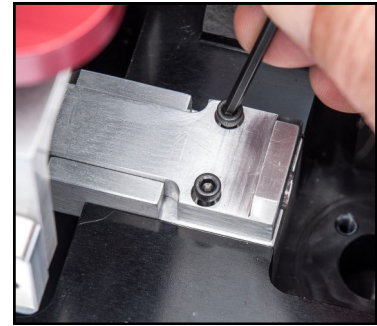

Tighten the two screws retaining the top plate of the air-box in-feed guide.

C. Drive Shaft Bearing Support

The drive shaft bearing supports are specific to the size of the fiber that you're blowing in order to maintain the center distance of the fiber running through the machine.

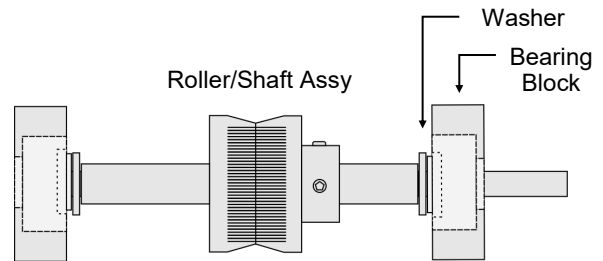
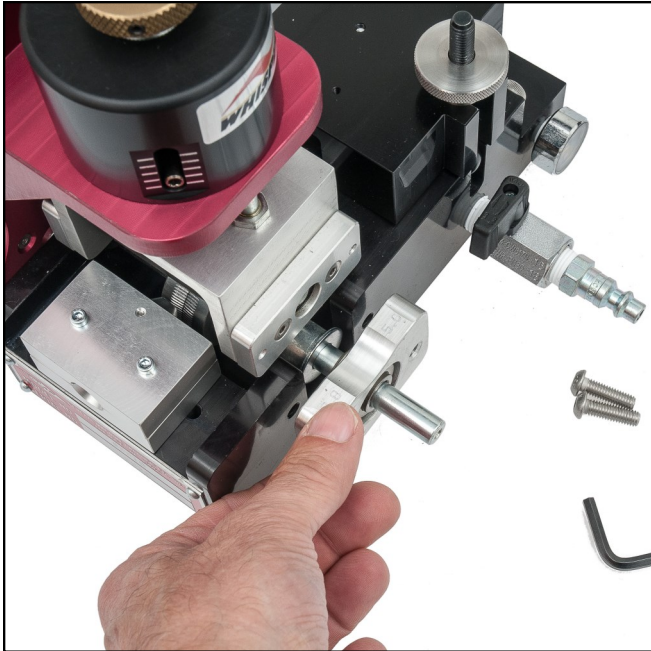

Install the flat washers.

Slide the bearing block over the shaft (dimple side up and bearing surface even with block towards outside) and secure with 2 screws.



Repeat on the other side.

Preparing the Whisper for the proper duct size

Measure the OD of the duct.
Select the corresponding tube collar and clamps

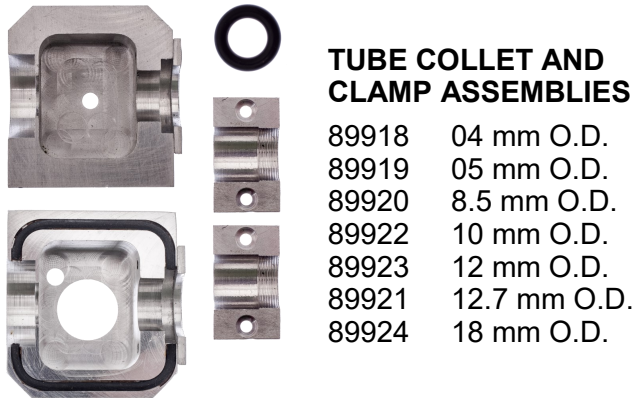

Loosen the thumb nut, rotate the swing bolt to open the airbox

Insert the the top and bottom airbox halves and tighten the screws

Insert the top and bottom tube clamps aligning the grooved edge to the outside. Tighten the 4 screws.

Other tube sizes available –Contact GMP for information.



Fit the tube into the airbox and tube clamp.

Slide a tube seal, sized for the tubing you are using, over the end of the tube.

Fit the tube half way or more into the airbox housing as shown in the photo, positioning the tube seal so that it sits against the seal face.

Positioning the tube further into the airbox helps prevent the buckling of smaller fiber.

Place a cable seal sized to the cable you are blowing in wide groove with the flat side to the outside of the air chamber. See illustration on right.

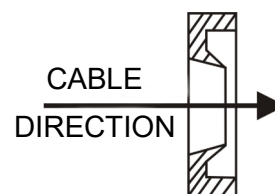
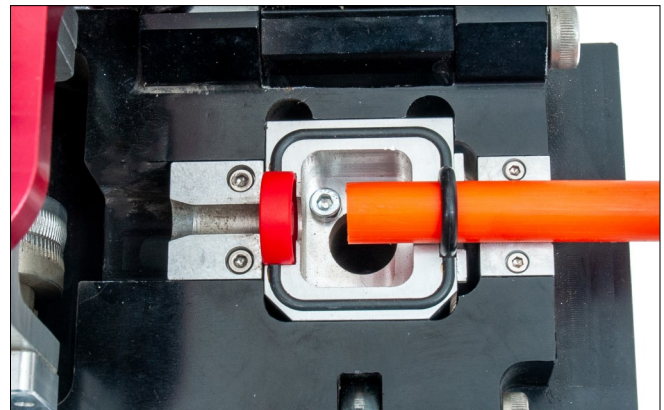

Fit the cable through the machine.



Back off the clamping screw turning CCW far enough to fit the cable between the rollers.



Pass the cable through the in-feed guide clamp, through the gap between the drive rollers. Continue to feed the cable through the cable seal into the airbox and into the duct.

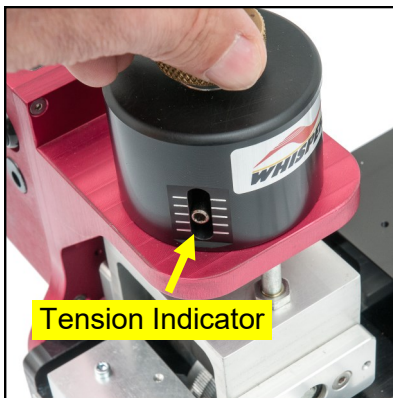

Tighten the clamping screw until the tension indicator is at the halfway mark. Some cables may require less clamping due to their size or construction. The amount of compression required will become clear as more experience is gained with the machine.

See appendix 2 for more information.

The cable is now positioned in the machine.

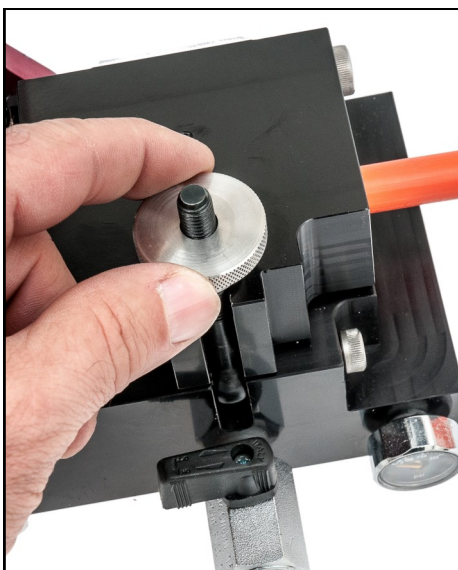

Tighten the airbox chamber/duct clamping screw tightly.

Connect the air supply to the machine.



The air inlet to the machine is a male fitting for a quick release coupling.

Check the battery with the battery level indicator.

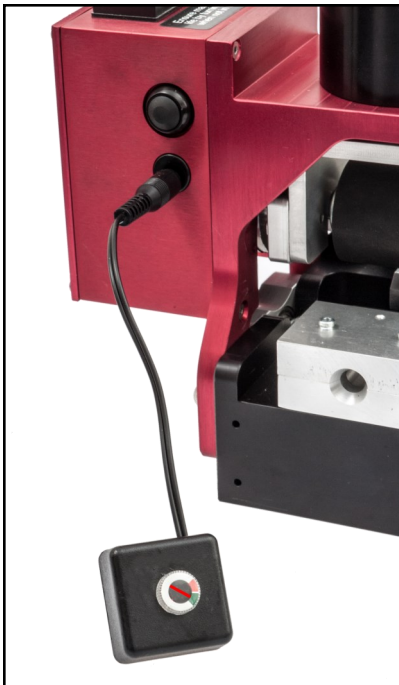

Connect the variable speed drill to the machine.

The Whisper is designed to operate with a commercial quality 3/8" variable speed drill, preferably 18 volts or larger.

See appendix 2 for proper setting of drill's clutch.



The machine is now ready to start the cable installation.

NOTE: THE MACHINE MUST NOT BE SUBMERGED IN WATER.

Installing Cable

Speed Distance indicator:

This device will measure and display the distance traveled by the cable and also the speed at which the cable is traveling. The functions are controlled by the small green push button on the right of the display. If this button is depressed twice, the display will “toggle” between speed and distance. Pressing the red button will reset the display to zero. Before starting an installation, it will be necessary to depress the red button to set the distance display to zero. Should it be necessary to replace the speed distance measuring indicator, it will be necessary to reprogram it.

To install cable:

1. Attach drill to Whisper drive motor shaft (if not already attached) and tighten drill chuck. Be sure that the drill is set in the forward or clockwise rotation setting and low speed.
2. Set drill torque setting starting at the minimum and work your way up.
3. Start air compressor and open air output valve, or if using nitrogen open the tank output valve to full flow. Keep the valve on the Whisper closed.
4. Activate cordless drill to desired speed and monitor distance and speed with the counter. Average installation speeds are between 150-300 FPM. It is sometimes necessary to gently hand assist the fiber cable into the cartridge to initiate forward motion. (Do Not Bend or Over Stress the cable.) When approximately 150' of cable is installed, gradually open the air valve on the Whisper
5. When cable exits duct end, take the desired amount of slack, stop drill and turn off air valve and allow it to vent all the residual air before opening airbox.
6. **Turn the power off on the counter to preserve battery life when not in use.**



Caution: If during the installation, the cable hits an obstruction and stops, immediately stop the drill. Continuing could severely damage the cable.

6. Maintenance

The GMP Whisper Cable Blowing Machine has been designed to give reliable, trouble free service over long periods. The machine requires no sophisticated maintenance procedures, simple common sense checks and precautions are all that are needed.

The main source of breakdown and/or malfunction of a machine being used outdoors is contamination by the elements, this contamination may be introduced into the machine in a number of different ways.

There may be mud, dust or other contaminants carried into the machine on the cable or tube (there may be surface coatings of lubricants or other release type agents on the outer surfaces of the cable and tube, this could build up on the rollers and make them slip).

The machine may be set down on a muddy surface, or be splashed by vehicles when it is being used by the roadside.

Battery Replacement

Remove the cover by removing 4 screws

Replace batteries (2) 9 volt Lithium recommended

Replace the cover and the 4 screws

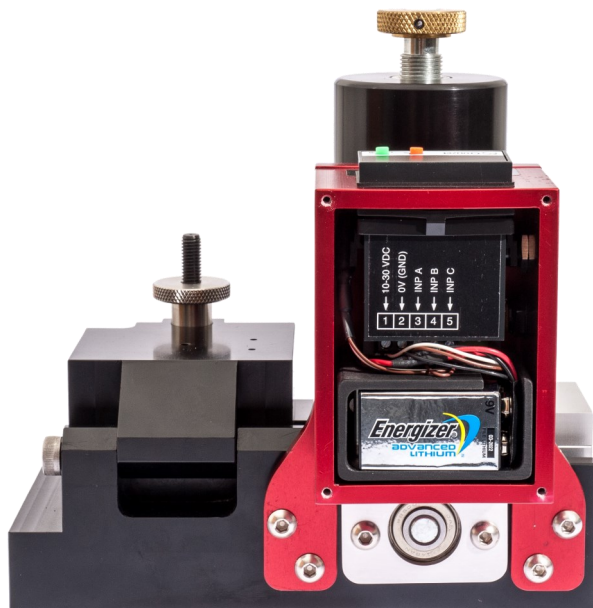

Battery Check—use supplied battery checker.

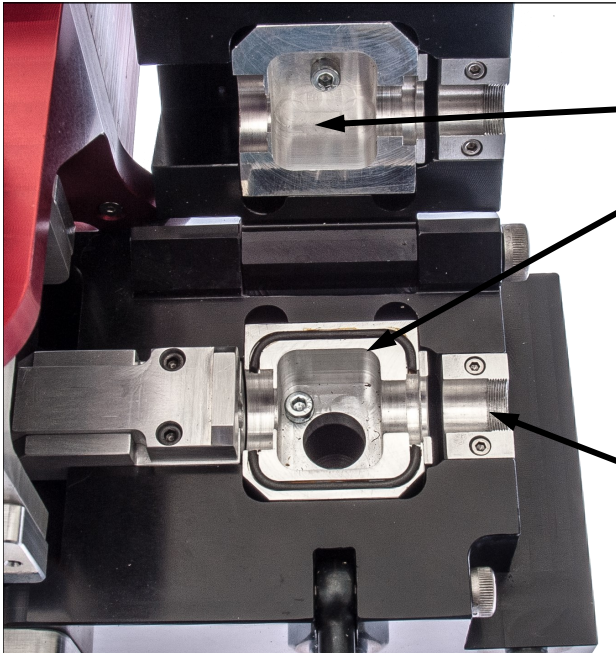

Airbox parts: Keep clean. A build up of moisture and dust will prevent the joint faces from mating, preventing the housing seal from sealing. Use any traditional workshop cleaning agent.

Tube clamp inserts: Keep clean. A build up of moisture and dust, particularly in the grooves, will reduce the clamping effect. Use any traditional workshop cleaning agent.

As a general rule, every time an interchangeable part is removed and replaced by a part of a different size, the part being removed should be thoroughly cleaned before being returned to its box. Similarly the cavity from which it was removed can also be cleaned prior to the assembly of the replacement part.

The machine should be returned to the General Machine Products Co., Inc., Trevoise, Pa. after every 1000 hours use (or at intervals of 12 months) for a major service.

Procedure for replacing the airbox housing seal



Cut a length of \varnothing 0.08inch sealing material 2 1/8" long (a little longer than is necessary).

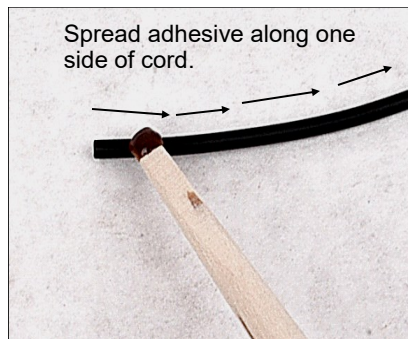

Apply a thin coat of 3M Rubber and Gasket Adhesive to the top of the cut sealing material

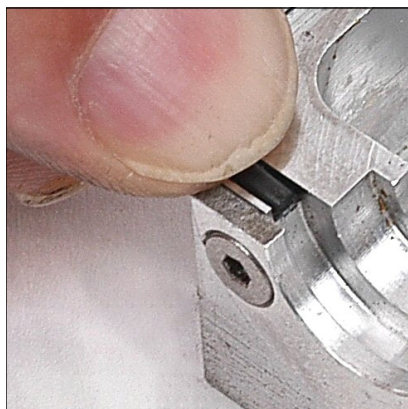

Place the pre-cut length in the groove, glue surface down, starting at the end with the retainer plate and aligning flush with the end of the groove.



Work your way around, pressing the seal into the groove and allowing the excess material to hang over the opposite side.

Repeat the procedure for the second groove



Trim excess material flush with end of groove.

7. Monthly service – check list

This section includes a list of suggested checks, it is recommended that these checks be carried out on a regular basis, depending on use. Monthly checks are convenient; a few minutes can be set aside on the same day of each month to complete these simple checks. The next section of this manual is an empty table, the dates when these checks and all other service and repair jobs are completed can be entered into the spaces provided in this table. This will give the user a record of what service has been carried out and when.

1. Check the tool box, ensure all tools and interchangeable parts are present, clean and ready for use.
2. Clean the outside of the machine, take care not to damage the rollers.
3. Check the top idler roller and ensure it runs freely, and that the speed/distance functions respond when the wheel is rotated.
4. Check the condition of the bottom drive roller, replace accordingly.
5. Clean the exposed threads on the swing bolts that hold the airbox and tube clamp assembly together. Add a smear of grease/oil* to prevent build up of surface corrosion and to insure smooth operation of the thumb nuts.

*Care should be given not to expose the drive roller to any grease or oil.

9. Tube integrity and Lubrication

Tube integrity and lubrication are entirely the responsibility of the operator.

To be sure that the tube into which the cable is to be inserted is installed appropriately, it is recommended that its integrity and lubrication be checked.

Check that the tube is:

1. Not blocked
2. Not crushed
3. Continuous (no breaks)
4. Also check that any couplers are pressure tight
5. Finally check that the tube is appropriately lubricated

The easiest and most straightforward way to complete these checks is to set the machine up for a normal cable insertion but fit a seal in place of the cable. The tube can then be pressurized without running the roller drive.

CAUTION: *Any object inadvertently left in the tube during the tube installation may be expelled from the end of the tube with high force and velocity. It is imperative that no personnel be in the vicinity of the end of the tube or that a suitable device is fitted to the end of the tube to arrest any expelled object.*

The checks listed at 1-4 (inclusive) above may all be carried out at the same time using one check. The procedure is outlined below. Set up the airbox and tube clamp as shown.

Fit the appropriate solid plug as shown

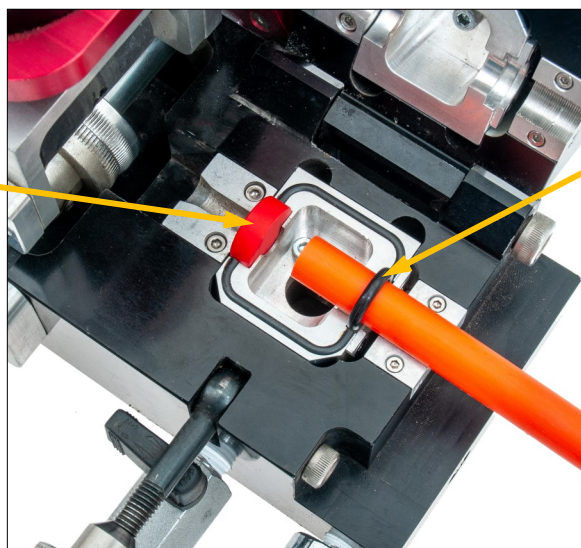

Fit the tube and tube seal in position as for normal cable installation.

When the airbox has been set up as shown in the photo, the airbox and tube clamp should be closed as for usual cable installation.

The airbox and tube clamp are now set up to blow air through the tube.

1. Connect the air as for normal blowing.
2. Make sure there are personnel at the other end of the tube run, and that they are aware that the air is to be turned on.
3. Make sure that a suitable device is fitted to obviate injury should any object be expelled from the far end of the tube.
4. Apply air to the Whisper

The far end of the tube run should be monitored; air should be leaving the tube under reasonable pressure. The minimum pressure required will vary with the length of tube in the run, the friction characteristics of the tube, the cable and the lubrication being used. As a starting point, the air leaving the far end of the tube should be (at least) similar to a light breeze. Bear in mind that if the tube run is of considerable distance, it may take a few minutes for the air to reach the far end of the tube.

If after waiting a suitable time there is no air leaving the far end of the tube, this would indicate that there is a blockage or similar obstruction in the tube run, or, that the tube is fractured. In either case the fault should be corrected before any attempt is made to blow cable through the tube.

Once the tube integrity has been confirmed by the method outlined above. The tube may be lubricated.

1. Open the airbox and tube clamp assembly, withdraw the tube and raise it so that the lubricant will pour into it easily and not overflow from the top.
2. Pour lubricant (available through GMP) of recommended quality and quantity down the tube.
3. Insert a suitable foam plug into the tube and put the tube back into the airbox and tube clamp.

The airbox and tube clamp assembly are now set up to blow the foam plug through the tube and deposit an even coating of lubricant to the inside walls of the tube.

1. Connect the air as for normal blowing.
2. Make sure there are personnel at the other end of the tube run, and that they are aware that the air is to be turned on. Make sure that a suitable device is fitted to obviate injury should any object be expelled from the far end of the tube.
3. Apply air to the Whisper

When the foam plug has been expelled from the far end of the tube run, cable can be installed into the tube.

Note: When the air is turned off, after checking the tube integrity and sending the foam plug down the tube to spread the lubricant, it may take some time for the pressure in the tube to fall back to low levels.

10. Recommended spares list

1. Tube Seals - See appendix 1
2. Cable Seals- See appendix 1
3. Drive Roller - 36319
4. Lubricant - 89568 (Polywater, 6 bottles per case)
5. Seal Cord - 89691
6. 9V Lithium Batteries - 30069 (pair)
7. Replacement Top Roller Kit - 36592

note: 36592 is for unit with pickup wheel only.
Call the factory if you have an encoder model.

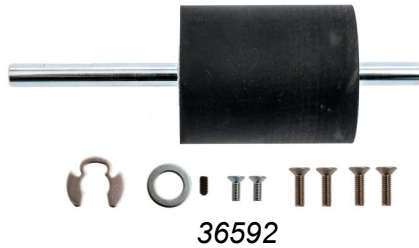

GMP Whisper Tool Kit



For spare parts always quote the machine type and serial number and contact:

General Machine Products (KT), LLC

3111 Old Lincoln Highway, Trevoze PA 19053 USA

TEL: +1 215 357 5500 FAX: +1 215 357 6216 Website: www.GMPtools.com



APPENDIX 1

This section lists the appropriate inserts, collets, etc. required for a given cable/tube combination.

GMP Whisper Configuration

In order to customize your new "Whisper" to your application, we ask that you pick, one each from the lists below, the Tube Collet Assembly P/N and the Cable Seal Collet Assembly P/N. When ordering, please have Tube and Cable dimensions available.

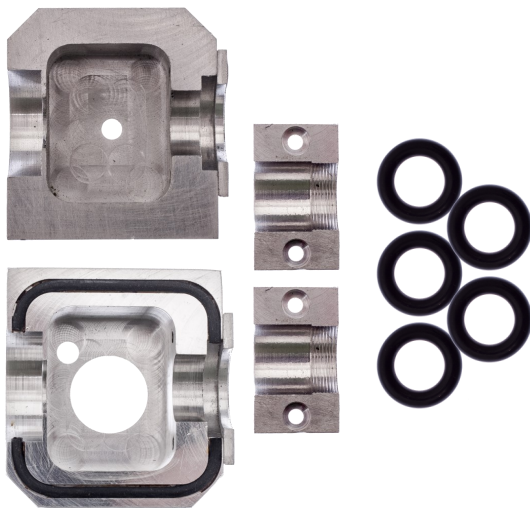
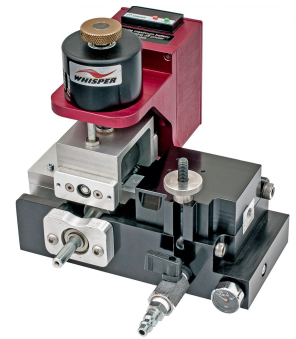

TUBE COLLET AND CLAMP ASSEMBLIES

89918	4mm O.D.
89919	5mm O.D.
89926	7mm O.D.
89927	8mm O.D.
89920	8.5mm O.D.
89922	10mm O.D.
89923	12mm O.D.
89921	12.7mm O.D.
89928	14mm O.D.
89925	16mm O.D.
89924	18mm O.D.

SPARE TUBE SEAL O RING (5 Pack)

89556	4mm
89549	5mm
89553	7mm
89550	8-8.5mm
89551	10mm
89552	12-12.7mm
89555	14mm
89554	16mm
89558	18 mm



CABLE SEAL COLLET ASSEMBLY

89932	3.0 - 3.8mm
89933	3.8 - 5.0mm
89934	5.0 - 6.4mm
89935	6.4 - 8.5mm

SPARE CABLE SEAL (5 Pack)

89511	3.0 - 3.8mm
89512	3.8 - 5.0mm
89513	5.0 - 6.4mm
89514	6.4 - 8.0mm
89515	8.0 - 8.5mm

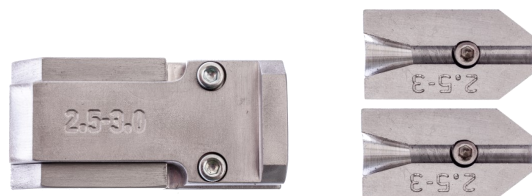

used with 89930, 89931
89932 and 89933

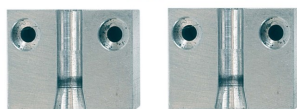

used with 89934 and 89935

GMP Whisper Configuration

Replacement Hardware

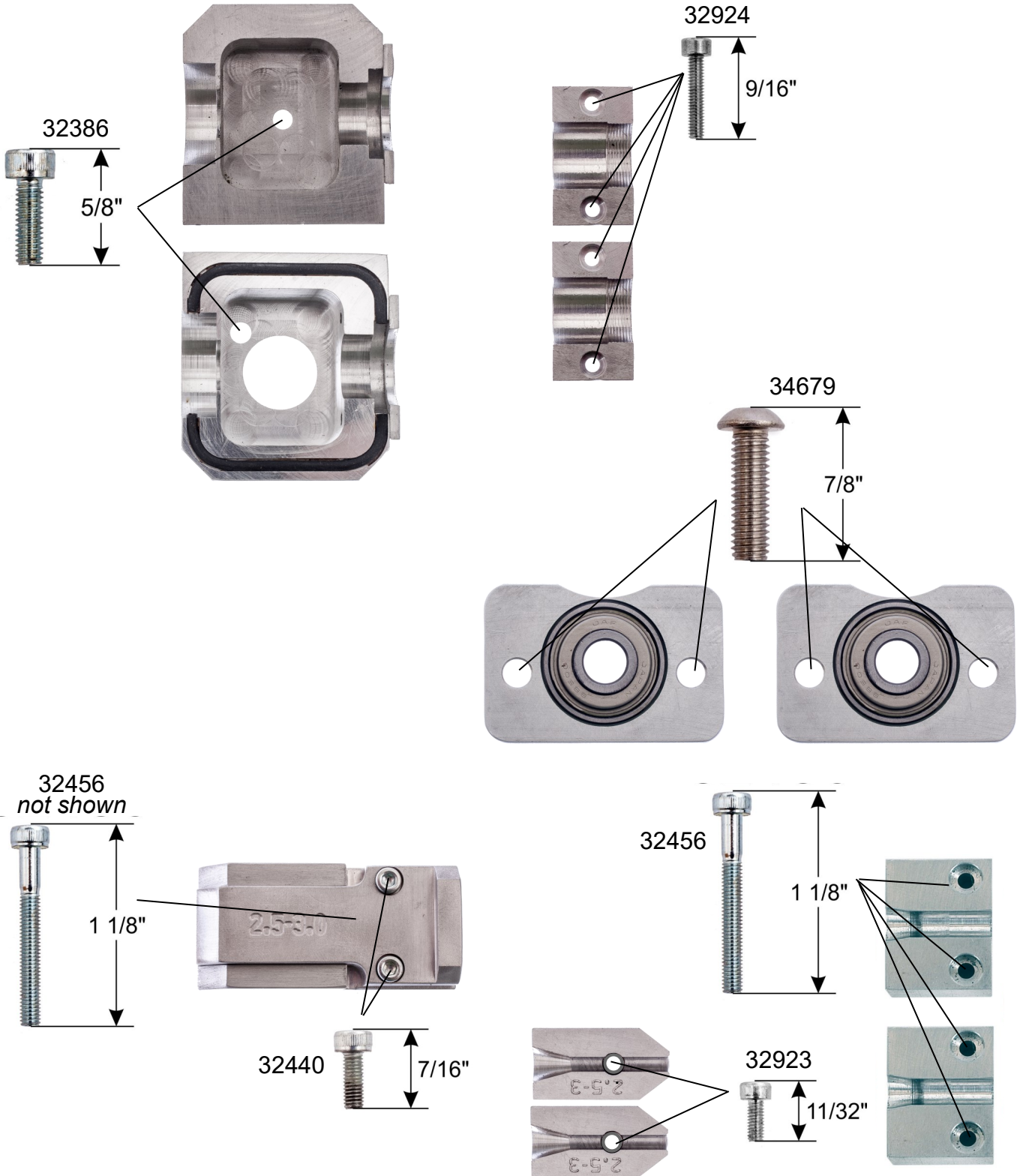

APPENDIX 2

Determining the correct drill torque setting

Select a sample of the cable to be used. Pass the cable through the machine as described in the manual. Feed the cable into the beginning of a length of sample tube (say 15' long). Seal the open end of the tube.

Set the drill's clutch to its lowest value (normally 0 or 1). Drive the cable hard into the sealed end of the sample length of tube. The roller will stop turning, this is because the torque limit has been reached. Repeat this procedure, each time turning the clutch up by one position. Eventually, the cable will buckle. The setting of the torque is now a little too far. Turn it back 1 position. This is the optimum setting.

APPENDIX 3

- Press and hold both ◀ and ▶ buttons.
 - After 5 seconds 'ProG' will be displayed. Releasing the buttons will display 'no'
- Press ▶
 - 'Yes' is displayed
- Hold ◀ and press ▶
 - 'InPol' is displayed
- Press ▶ until 'nPn' is displayed
- Hold ◀ and press ▶
 - 'Filter' is displayed
- Press ▶ until 'oFF' is displayed
- Hold ◀ and press ▶
 - 'InPut' is displayed
- Press ▶ until 'Cnt.dir' is displayed
- Hold ◀ and press ▶
 - 'FAc.Cnt' is displayed
- Press ◀
- Enter value 00.0116 for meters, 00.0380 for feet for units with proximity switch (see image 1 for ID)
- Enter value 00.0006 for meters, 00.0019 for feet for units with encoder (see image 2 for ID)
 - Use ◀ to move to next digit
 - Use ▶ to increment digit (this instruction applies to all following number inputs)
- Hold ◀ and press ▶
 - 'diV.Cnt' is displayed
- Press ◀
- Enter value 01.0000
- Hold ◀ and press ▶
 - 'dP.Cnt' is displayed
- Press ▶ until '0' is displayed
- Hold ◀ and press ▶
 - 'rES.Cnt' is displayed
- Press ▶ until 'MANrE' is displayed
- Hold ◀ and press ▶
 - 'FAc.tAc' is displayed
- Press ◀
- Enter value 00.0116 for meters, 00.0380 for feet for units with proximity switch (see image 1 for ID)
- Enter value 00.0006 for meters, 00.0019 for feet for units with encoder (see image 2 for ID)
- Hold ◀ and press ▶
 - 'diV.tAc' is displayed
- Press ◀
- Enter value 01.0000
- Hold ◀ and press ▶
 - 'dP.tAc' is displayed
- Press ▶ until '0' is displayed
- Hold ◀ and press ▶
 - 'disPm' is displayed
- Press ▶ until 'Min-1' is displayed
- Hold ◀ and press ▶
 - 'Wait0' is displayed



Image 1
With Proximity Switch











Image 2
With Encoder

No Cover

Cover

(over)

- Press 
 - Enter value 01.0
 - Hold  and press 
 - o 'EndPro' is displayed
 - Press  until 'YES' is displayed
 - Hold  and press 
 - o Programming completed
- OR
- Press  until 'no' is displayed
 - Hold  and press 
 - o Programming mode restarted

Whisper Optional Accessories

Convert your round fiber Whisper to a flat drop blowing machine.

Flat Drop Conversion Kits

- 89951 Corning ROC
- 89952 Corning SST
- 89954 Corning ROC Fast Access
- 89956 Commscope



Whisper Tripod Mounting Kit

- Lightweight and durable
- Positive locking clamps
- Made of space-age aluminum alloy
- Flat Head design
- Easy Setup
- Built in shoulder strap
- Folds for storage
- Max work height 63" (160 cm)



P/N 89945 Weight: 9 lbs. (4.1 kgs)

Drill Stand



This option helps support the drill for long fiber blows. Attaches to the tripod and fully

P/N 89948 Weight: 2 lbs. (.90 kgs)



Bottled Nitrogen Kit

P/N 89742 Weight: 4.5 lbs. (2 kgs)

Air Compressor

The Air Compressor is designed specifically for use with our Micro Fiber Cable Blowing Machines. This reliable & efficient screw compressor, powered by a gasoline engine, provides a maximum working pressure of 220 psi (15 bar) with 35.3cfm (1000 litres/m) flow.



Engine: Honda 21 hp
Fuel Cap.: 5 gal (20 liters)
Length: 42" (1070 mm)
Width: 31" (800 mm)
Height: 30" (780 mm)
Weight: 487 lbs. (221 kg)

P/N 89011 Weight: 487 lbs. (221 kgs)

Whisper Air Hose

P/N 89949 Weight: 2 lbs. (.9 kgs)

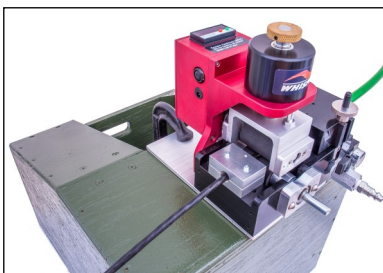

Mounting Plate

P/N 89947 Weight: 1 lbs. (.45 kgs)



General Machine Products, (KT), LLC •
3111 Old Lincoln Hwy • Trevose, PA 19053 • USA
TEL: +1-215-357-5500 • FAX: +1-215-357-6216 • EMAIL: info@gmptools.com